

4

3

2

1

D

D

C

C





B

B

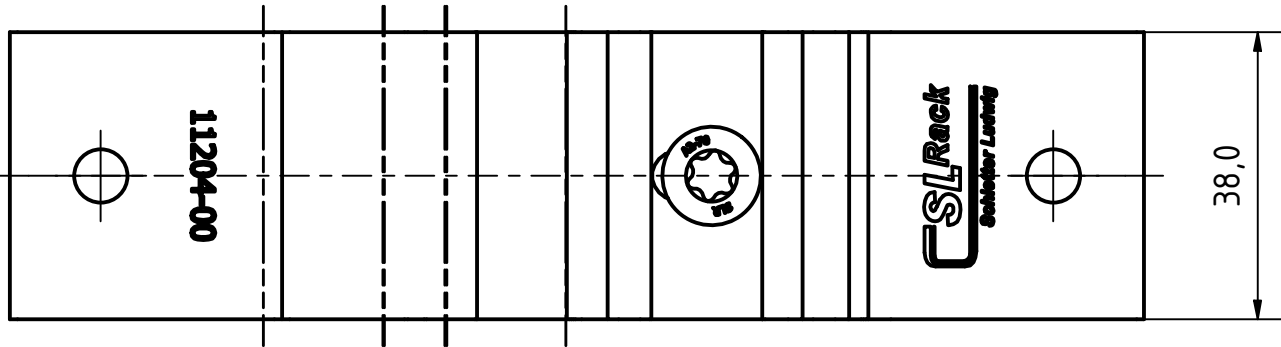
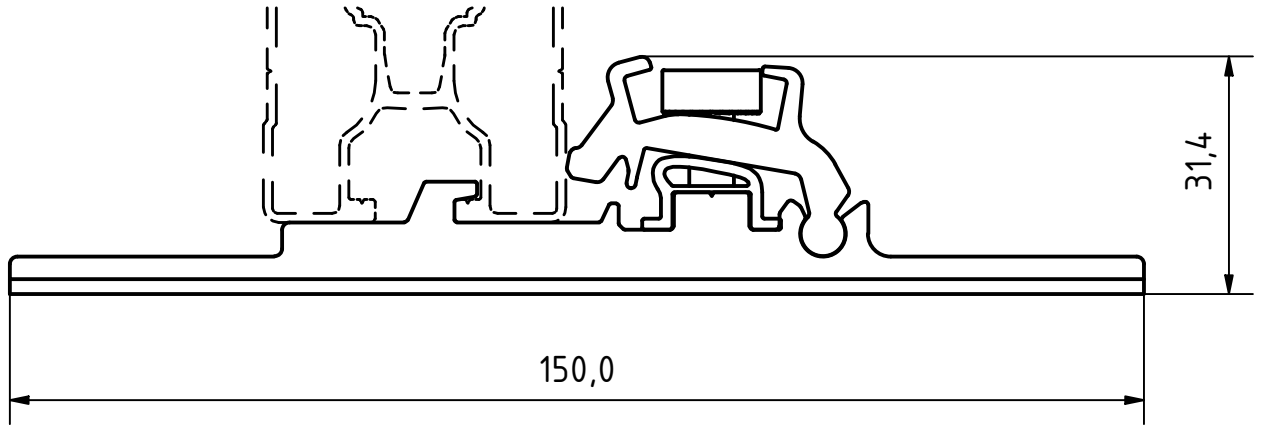
A

A



 SL Rack Schletter Ludwig		Material:		Maßstab:		Kunde:		Information:	
				1 : 1				Information:	
Besonderheiten:		Datum		Name		Bezeichnung/Kommentar/Projekt:			
Werkzeugnummer:		Bereich:		Gezeichnet		Trapez 4 - 2.0			
Gewicht:		kg/m		Kontrolliert		Trapezdach			
Dichte:		Volumen:		Freigegeben		Zulieferer:			
2,4541 g/cm ³		55069,965 mm ³		Oberflächenangabe:		-		SL Rack GmbH	
  		Toleranzangaben:		Projektionsmethode:				Artikelnummer: 11204-00	
Stafus		Änderungen		Datum		Name		Speicherpfad:	
								1	
								A4	

4

3

2

1

Alle Rechte vorbehalten. Vervielfältigungen jeder Art nur unter ausdrücklicher, schriftlicher Zustimmung der Fa. SL Rack GmbH